

TRACO – Introduction to Radiation Oncology

Elizabeth Nichols, MD

Associate Professor

University of Maryland

Marlene and Stewart Greenebaum Cancer Center

10/15/24

enichols1@umm.edu

Disclosures

- Disclosures: None

Outline

- Goals of cancer therapy
- Goals of radiation therapy
- Basics of radiation oncology
 - Radiation Physics
 - Radiation Biology
 - Radiation Therapy
 - Patient presentations
- The future of radiation oncology

Principles of cancer therapy

- Minimize therapy
 - Toxicity, time, cost
- Minimize negative impact on quality of life
 - Toxicity, function, cosmesis
- Improve quality of life
 - Palliation, organ preservation
- Maximize impact on quantity of life
 - Cure and remission
- Improve outcomes
 - Research

Radiation Oncology

The discipline of radiation oncology

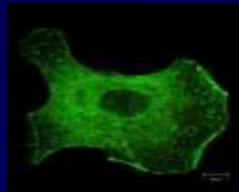

Radiation Biology

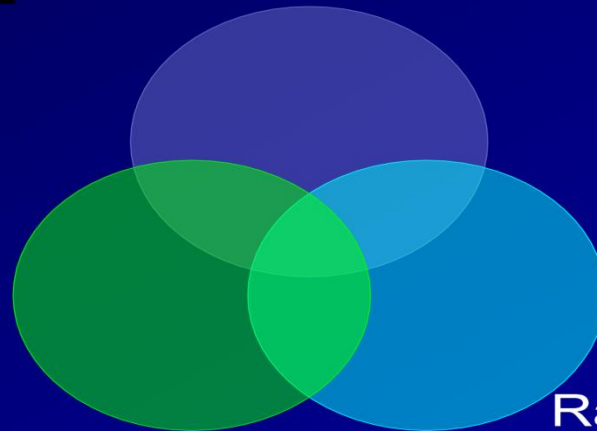

Physics

$$E=mc^2$$



Radiation Therapy



The Physics of Radiation Oncology

Just the basics

The Physics of Radiation Oncology

- What is radiation?
 - “the complete process by which energy is emitted by one body, transmitted through an intervening medium or space, and absorbed by another body.”

Types of Radiation

Types of Radiation

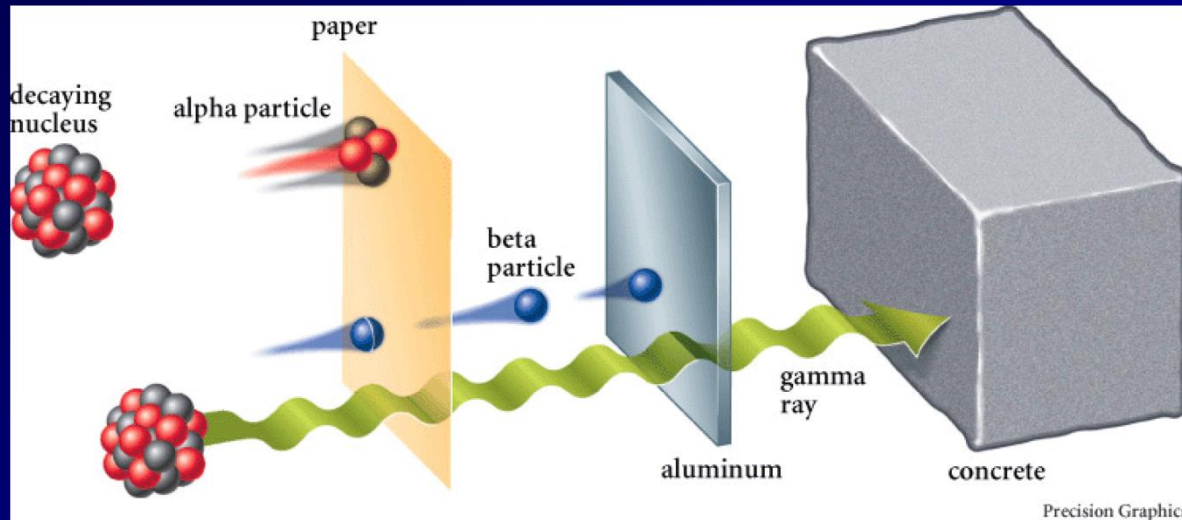

Particles and photons

The Electromagnetic Spectrum

The electromagnetic spectrum

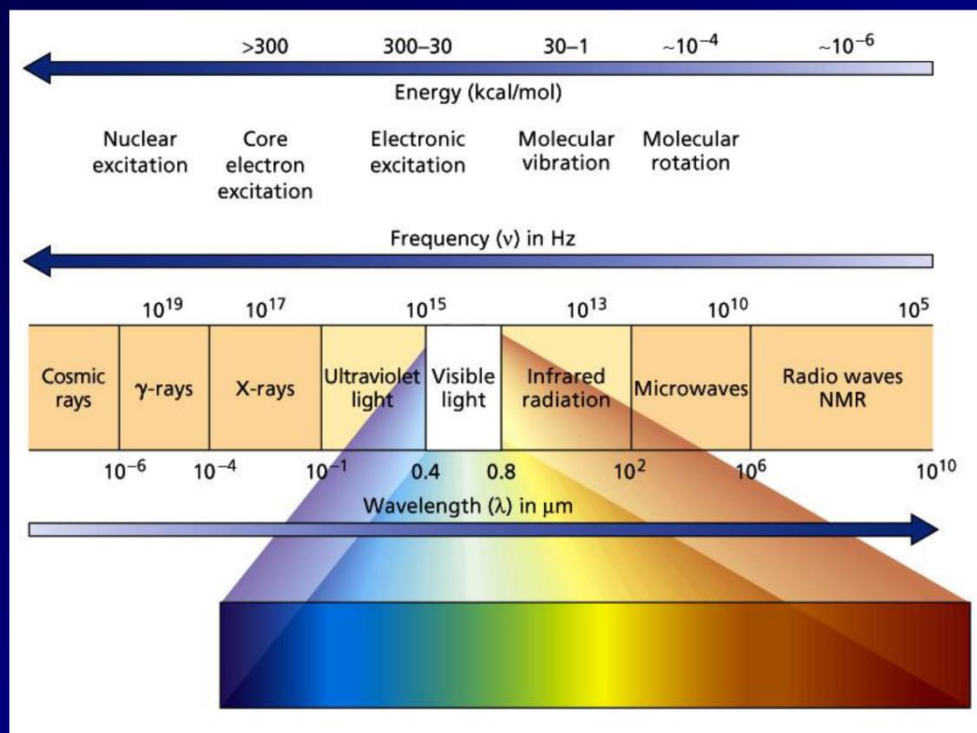

X Rays

How are x rays generated?

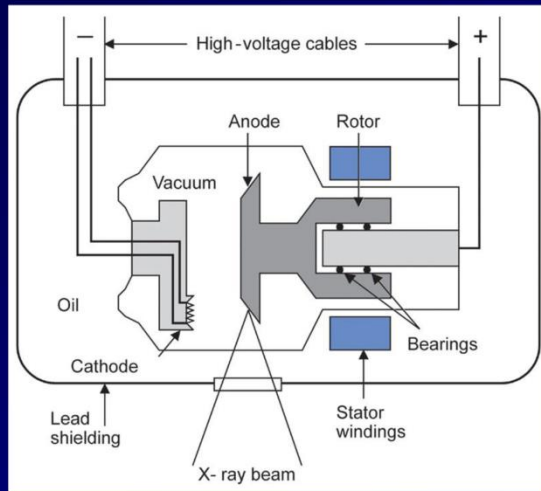

The Linear Accelerator

The linear accelerator

- High energy photons and electrons
- Uniform beam characteristics
- Precise field shaping
- Precise delivery
 - The gantry rotates
 - The couch rotates
 - The patient is immobilized

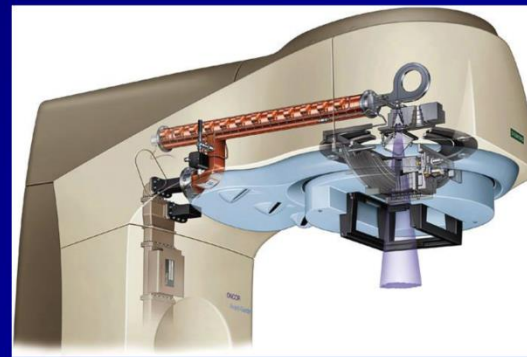
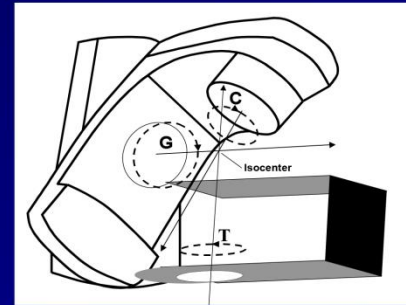

Radiation therapy basics

Radiation Therapy Basics

- GTV = Gross tumor volume
- CTV = Clinical target volume; typically margin added for microscopic extension; may be limited at anatomic boundaries
- PTV = planning target volume; isotropic margin to account for 'set up uncertainty'.
- ITV = internal target/tumor volume; volume drawn accounting for organ or tumor motion

Radiation Planning Techniques

Radiation Planning Techniques

- 3D CRT
 - Use CT to plan from anatomy, allows freedom of multiple angles
 - “Virtual patient”
- IMRT
 - Dose cloud, complex
 - Inverse planning

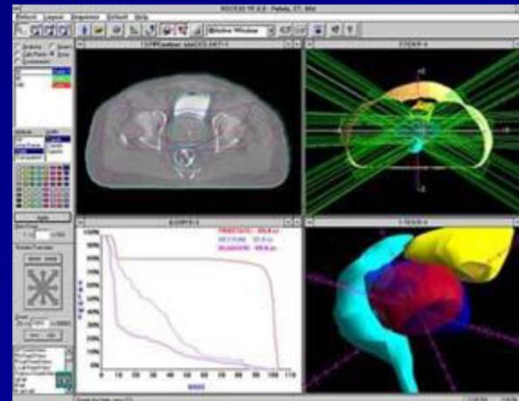
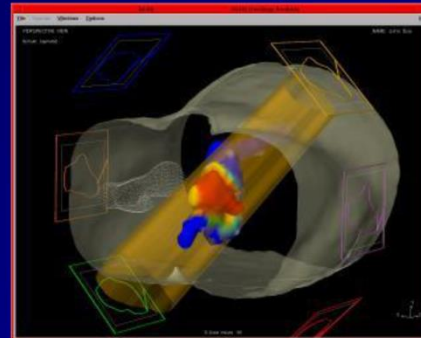

Intensity Modulated Radiation Therapy

Intensity Modulated Radiation Therapy

- Modulation of the intensity across each beam
- Allows customization based on a specific planning objective
 - Treat tumor to 50Gy, keep bladder dose below 20 Gy.

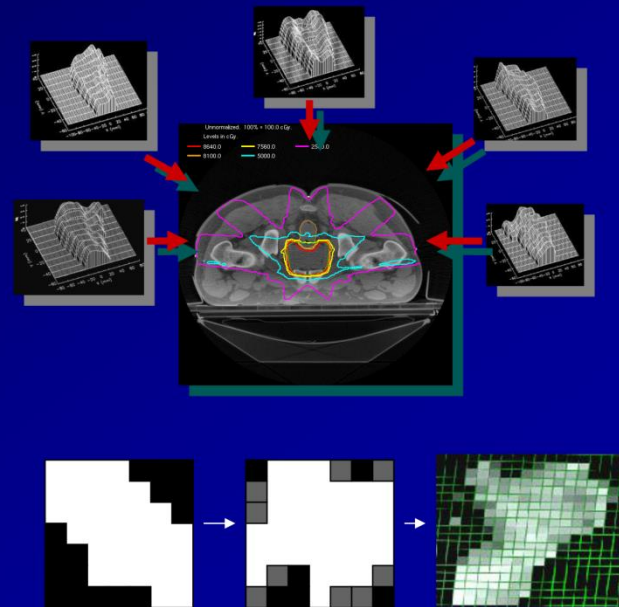

VMAT

Volumetric Modulated Arc Therapy (VMAT)

- Linac moves and can deliver dose in 360 arc around patient
- Quicker treatment delivery
- More conformal for moderate dose of prescription
- Improved dose homogeneity
- More low dose to surrounding tissues

Brachytherapy

- Placing a radiation source inside or adjacent to the tumor
- Rapid dose fall-off allows maximal sparing of normal tissues (no “going through” normal tissue to get to the tumor)
- Used commonly for tumors
 - in body cavities (cervix, endometrium, vagina, nasopharynx)
 - close to the surface (prostate, sarcoma, tongue, lip, breast)

Plaque Simulator Isodose Plot

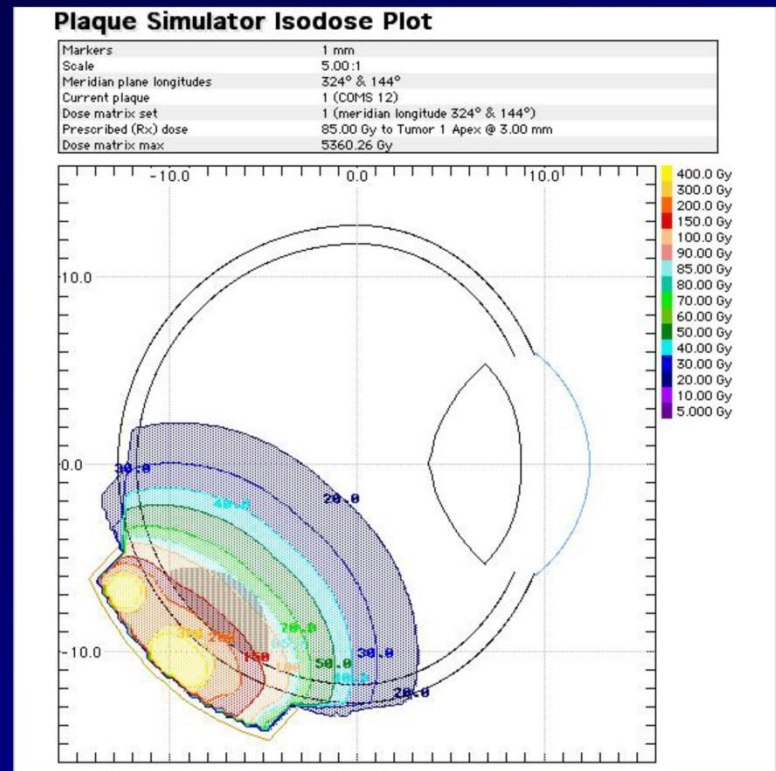

Brachytherapy

Brachytherapy

- Placing a radiation source inside or adjacent to the tumor
- Rapid dose fall-off allows maximal sparing of normal tissues (no “going through” normal tissue to get to the tumor)
- Used commonly for tumors
 - in body cavities (cervix, endometrium, vagina, nasopharynx)
 - close to the surface (prostate, sarcoma, tongue, lip, breast)
- Delivered with Iridium-192

Brachytherapy

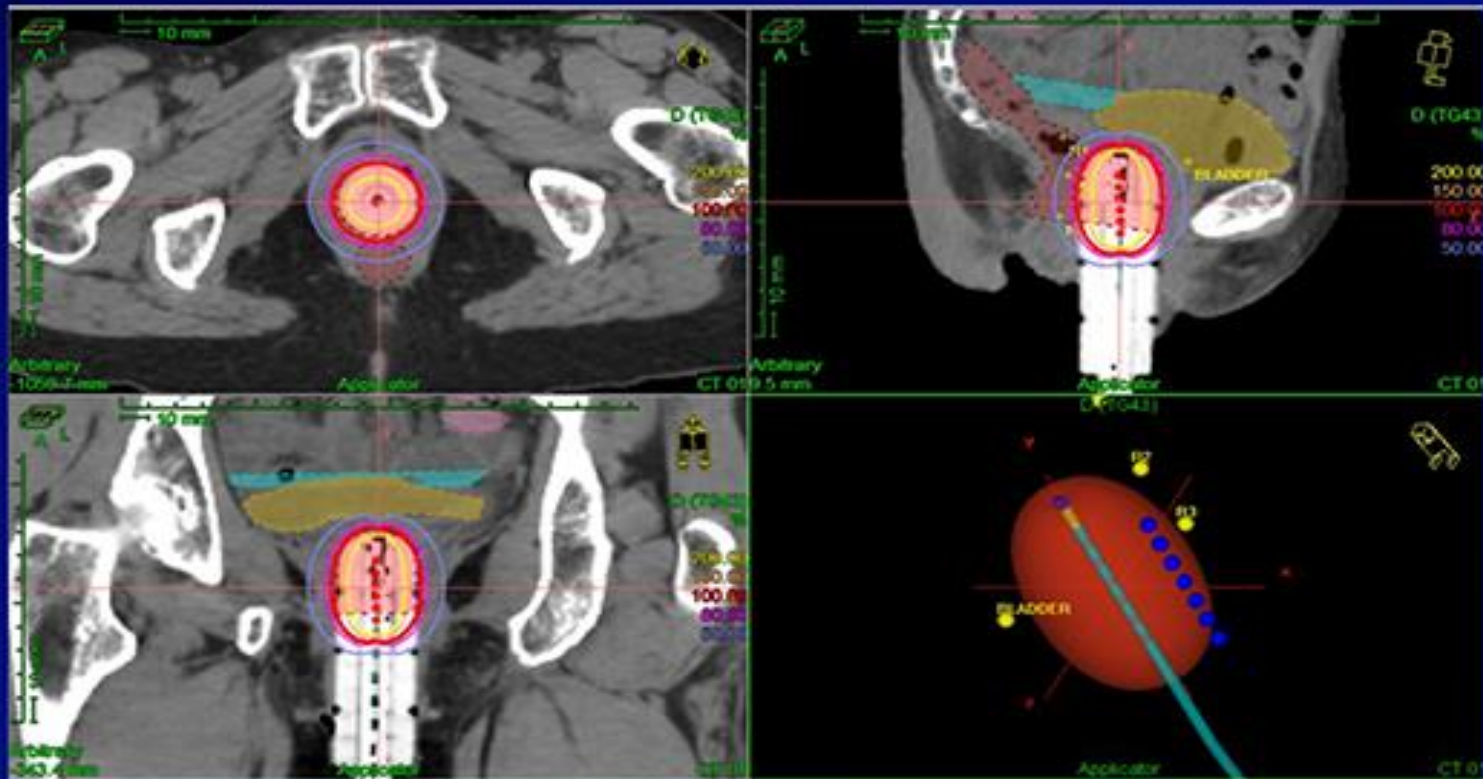

Brachytherapy

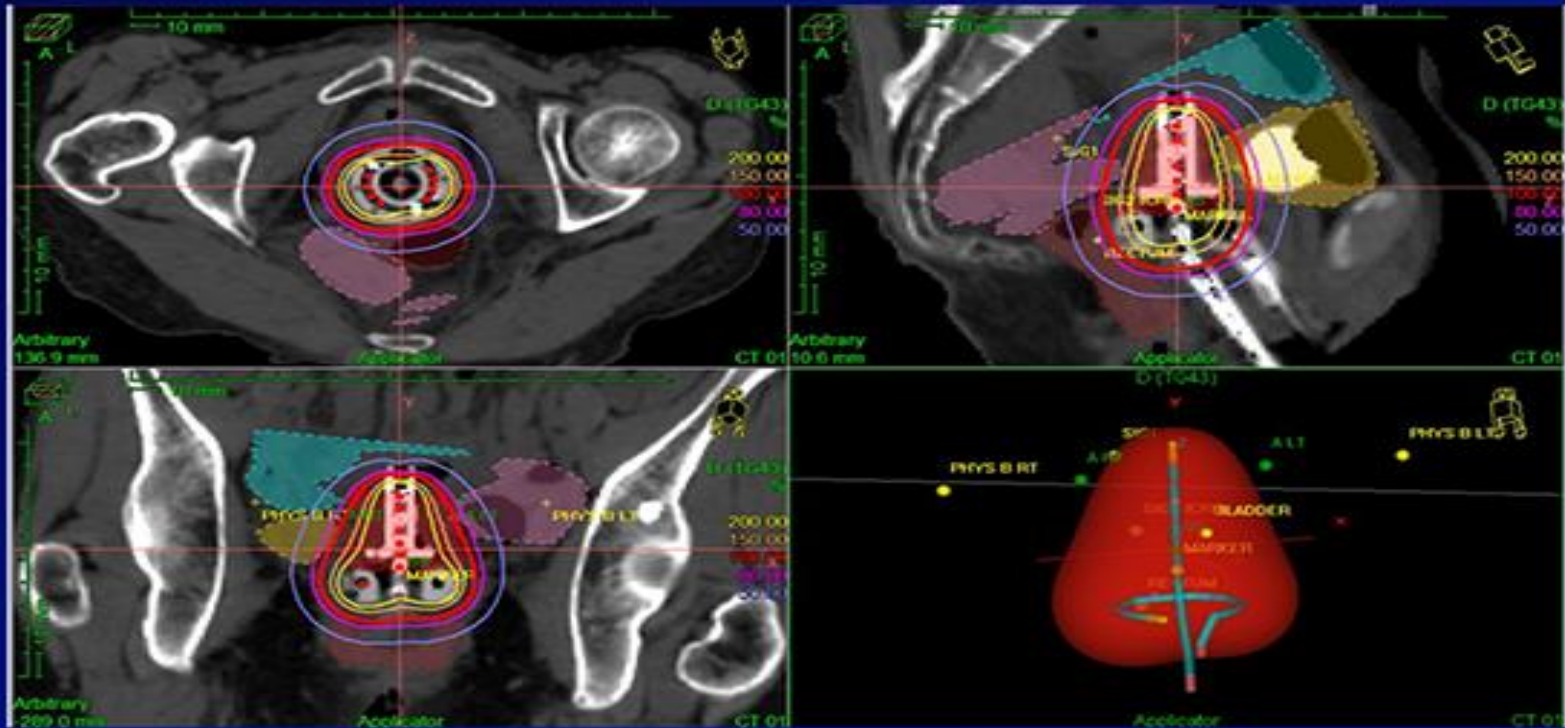

Brachytherapy

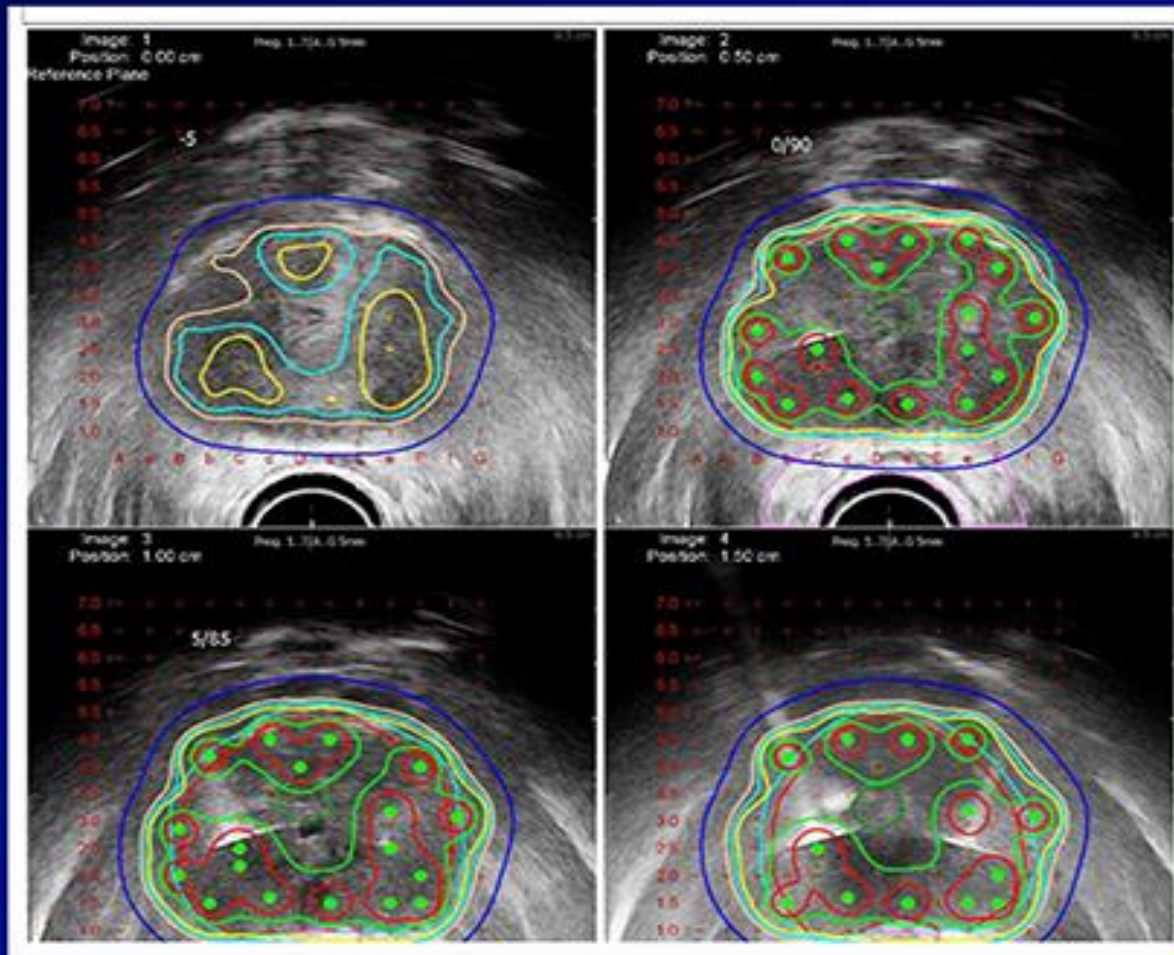

Stereotactic Radiosurgery

Stereotactic Radiosurgery

- Historically used to treat brain tumors (Gamma Knife)
- Technology has developed where we can now treat tumors in other body sites (**S**tereotactic **B**ody **R**adiation **T**herapy)
 - Lung
 - Liver
 - Bone
- Cyber knife is a brand of machine that delivers stereotactic radiosurgery

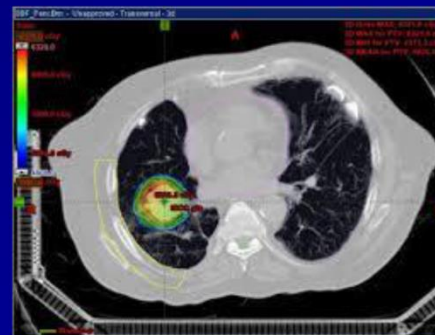
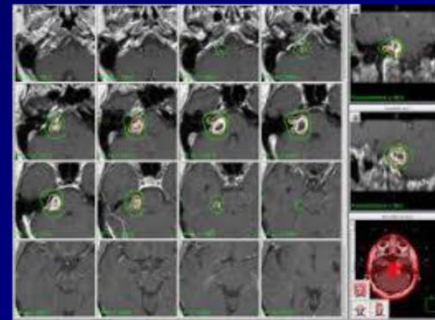

Radiation Biology

Radiation Survival Curve

Radiation survival curve

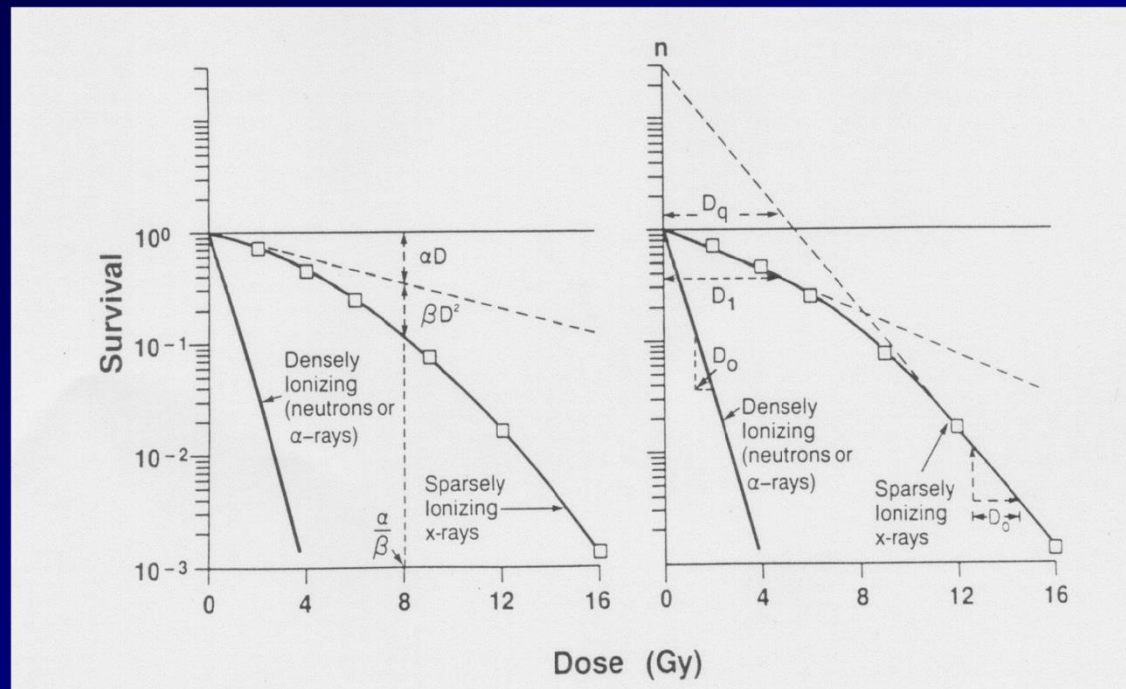

Fractionation

Fractionation

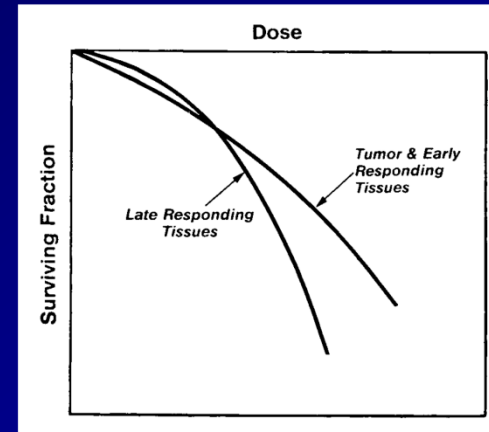
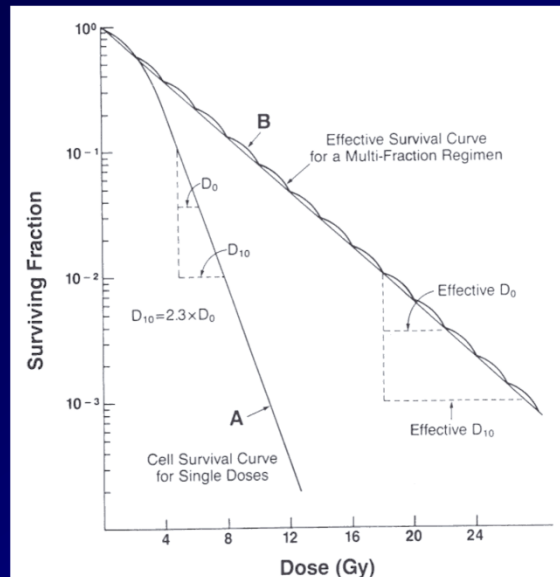

Rationale: take advantage of the slightly improved survival of normal tissue to smaller doses, amplified over many treatments

The 4 “R”s of fractionated radiation

- Repair
 - Healthy cells repair DNA damage (so do tumor cells unfortunately)
- Reassortment (redistribution)
 - Radiation causes cells to accumulate in certain phases of the cell cycle
- Reoxygenation
 - Tumors reoxygenate after radiation
- Repopulation
 - Tumor and normal cells repopulate between doses of radiation

Repair

Repair

- DNA is the primary target of radiation
 - Indirect
 - Direct
 - SSB are repaired
 - DSB are key!
- Particles
- Photons

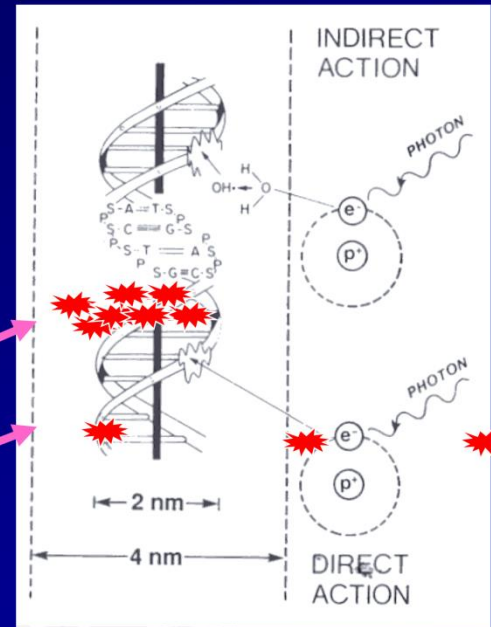

Cells that correct DNA dsb go on to divide another day.....REPAIR.

Redistribution

Redistribution

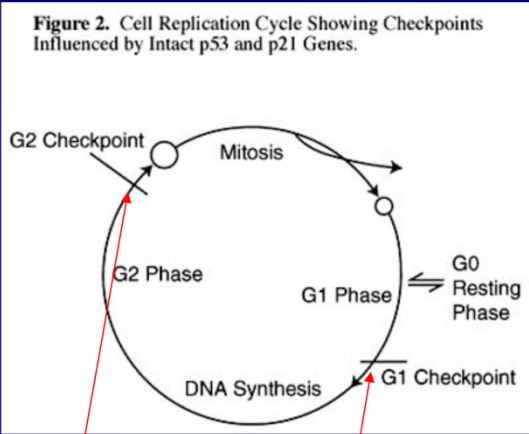
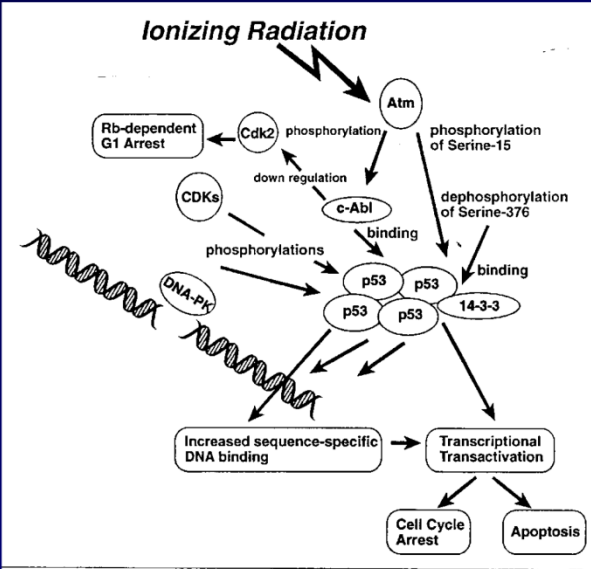

Radiation induces cell cycle arrest to repair DNA damage.....REDISTRIBUTION

Cell Cycle and Radiation Sensitivity

Cell cycle and radiation sensitivity

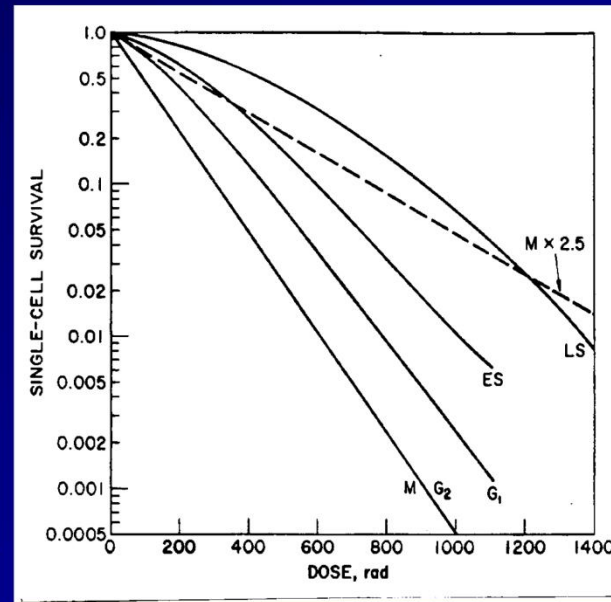
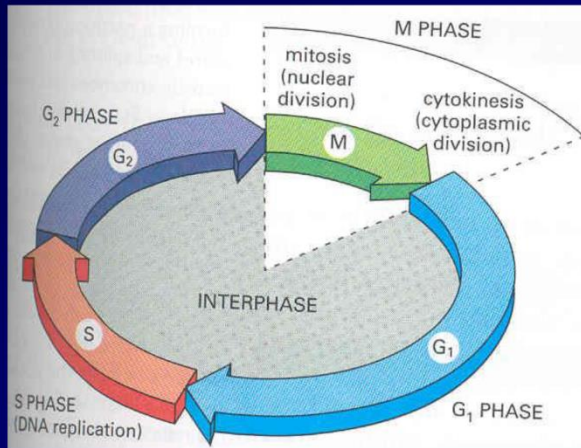

M > G₂ > ES > LS

Redistribution into a sensitive phase can matter!

Reoxygenation

Reoxygenation

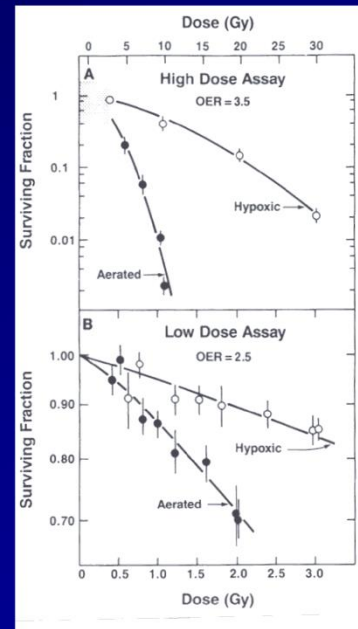
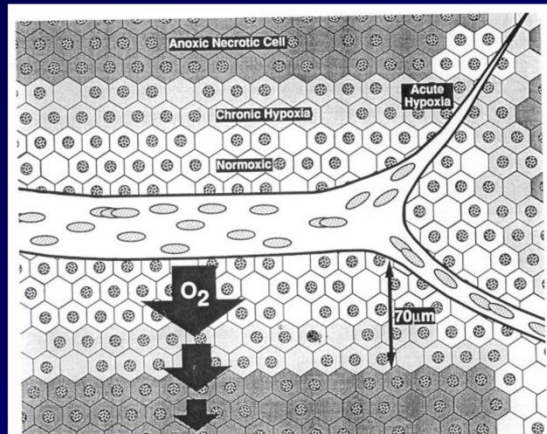

Following radiation, tumors reoxygenate rapidly.....REOXYGENATION

Radiation Modifiers

Radiation Modifiers

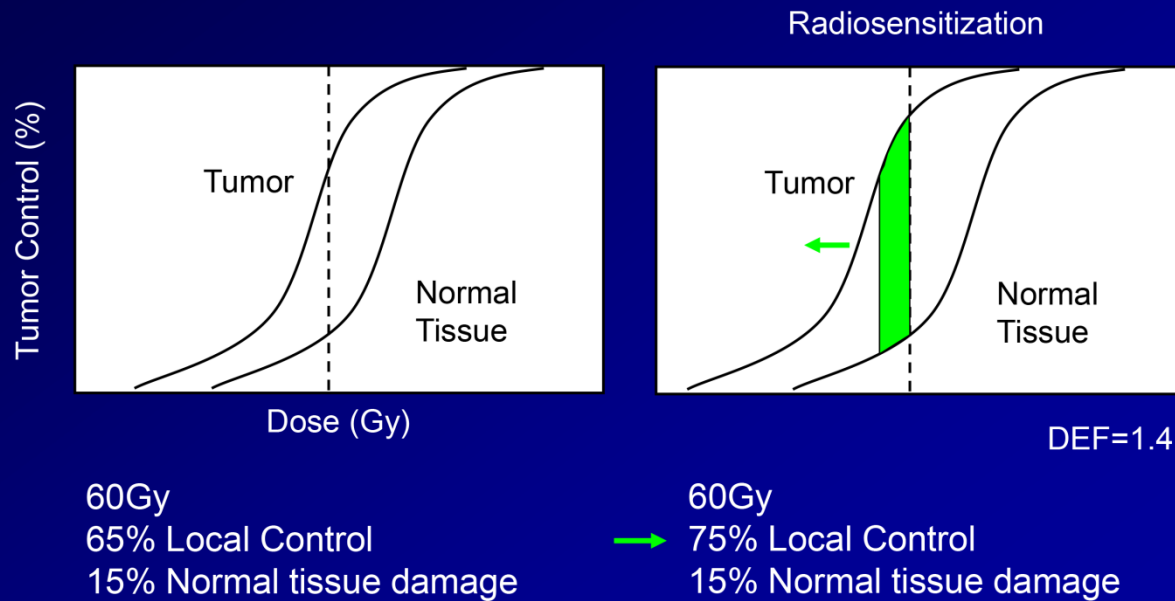

Radiation Modifiers

Radiation Modifiers

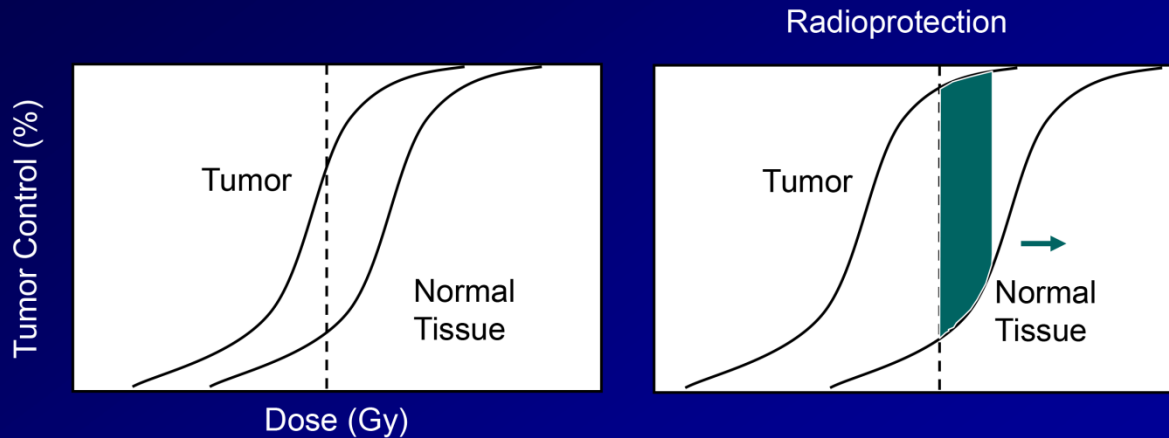

60Gy
65% Local Control
15% Normal tissue damage

70Gy
75% Local Control
15% Normal tissue damage

Radiation Targets

- Single Target Agents
 - Growth factor receptors (EGFR, VEGFR)
 - DNA repair proteins (DNA-PK, Rad51)
 - Transcription factors (NFkB, p53)
 - Signal transduction proteins (Ras, PI3K, c-Abl)
- Multi-target Inhibition
 - Chaperone proteins (HSP90 inhibition)
 - Microenvironment (angiogenesis, vasculature)
 - Epigenetic modification
- Radiation Inducible Targets
 - Antigens or receptors (Fas, CEA)

Radiation targets

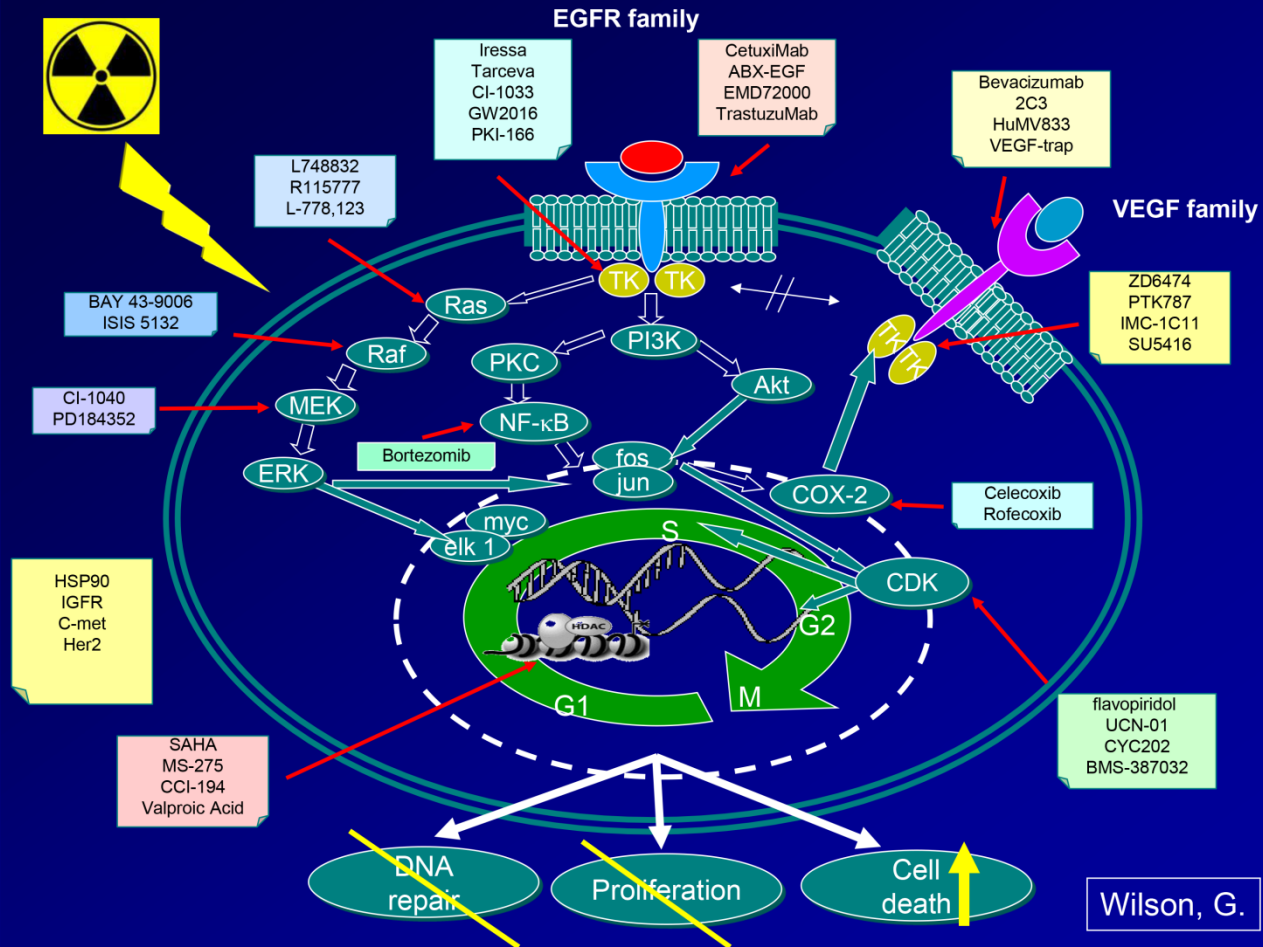

Issues for Target/Agent Development

- Mechanism
 - Cell type or condition specific
- Method of Targeting
 - Antibodies (EGFR, VEGFR)
 - Small molecules (Gleevec, Flavopiridol)
 - Gene therapy (TNFerade)
- Therapeutic ratio
 - Tumor > normal cells (Rad51)

Immunomodulatory agents

Immunomodulatory Agents

- Can be combined well with RT
 - Abscopal effect
- Types of agents
 - PD1
 - PDL1
 - Others

Abscopal Effect

Abscopal Effect

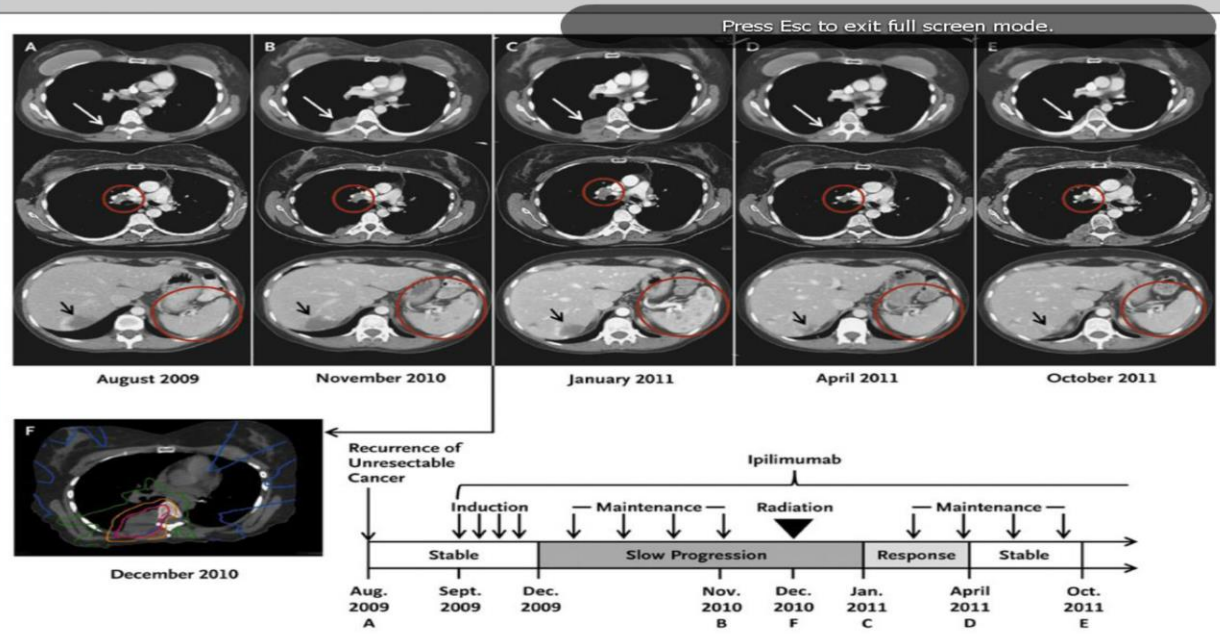

Figure 1. Results of Diagnostic and Radiotherapy Simulation Imaging throughout the Disease Course.

Axial CT images are shown, corresponding to the timeline showing therapy and disease status. White arrows indicate the paraspinal mass, red circles indicate the right hilar lymphadenopathy and spleen, and black arrows indicate an incidental hepatic hemangioma. Panel A (top) represents the status before treatment with ipilimumab. Panel B shows enlargement of the paraspinal mass (top), stable right hilar lymphadenopathy (middle), and new splenic lesions (bottom). Panel C shows images 1 month after radiotherapy, when the response to radiotherapy had not yet occurred, with apparent continued worsening disease at all three sites. Several months after radiotherapy, the targeted paraspinal mass showed a response (Panel D, top). Furthermore, disease response outside of the radiation field was seen with decreased right hilar lymphadenopathy (middle) and resolution of splenic lesions (bottom). The response was durable, as shown in Panel E. Panel F shows the CT simulation image for radiotherapy planning, with the target volume (indicated in purple) encompassing the right paraspinal metastatic mass.

Radiation Therapy

Clinical practice

Goals of radiation therapy

- Cure
 - Cancer localized to one organ or region
- Palliation
 - Cancer disseminated to multiple organs that are causing bothersome symptoms

Indications for radiation therapy

- Cure
 - Prostate cancer
 - Other urologic cancers
 - Breast cancer
 - Lung cancer
 - Head and Neck Cancer
 - Gynecologic Cancers
 - Pediatric Cancers
 - CNS tumors
 - Skin cancers
- Palliation
 - Bone pain
 - Shortness of breath
 - Neurologic symptoms
 - Pain from a space occupying lesion

The Oncology Team

The oncology team



Develop a multimodality plan

- Surgery
- Radiation
- Systemic therapy
 - Chemotherapy
 - Targeted agents
- Other localized therapies
 - Focal ablation techniques
 - Focal drug delivery

Treatment Process

The radiation therapy treatment process

- Following consultation visit
- CT simulation (planning session)
- Transfer of images to treatment planning system
- Fusion of outside images



CT

CT simulation

- Wide bore CT present in all radiation oncology departments
- Flat table top (instead of curved)
- Immobilization devices created
- “Marks” placed on patient for alignment and treatment
- Ability to do 4D CT

CT scan

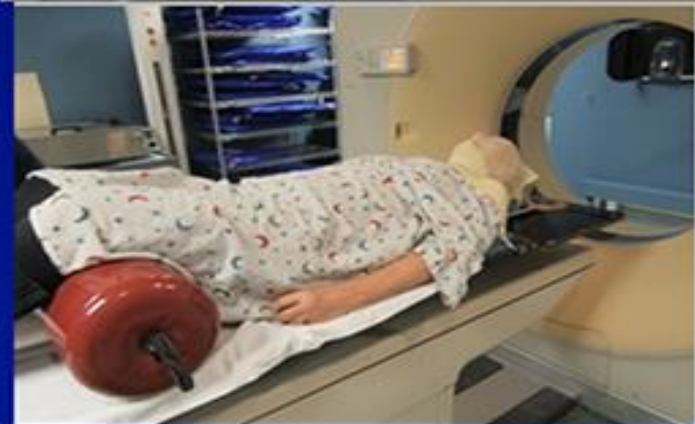
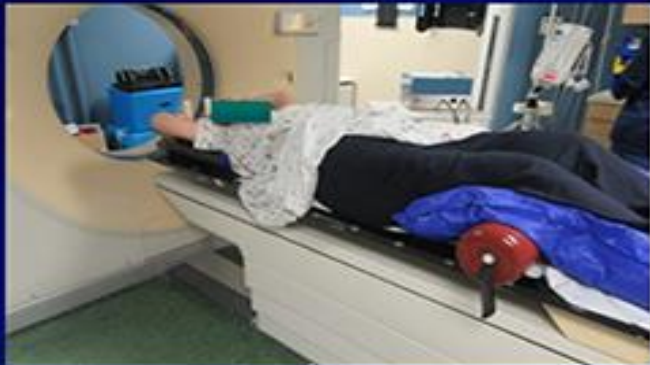

Radiation therapy process

The radiation therapy treatment process

- Contouring (normal structures, target structures)
- Creation of plan (dosimetry)
- Evaluation of plan (by MD)
- Evaluation of plan (by physics)
- Transfer of plan to treatment machine
- Treatment delivery

ROI Image

The screenshot displays a medical software interface for ROI (Region of Interest) management. The interface is divided into several sections:

- ROI Tools:** Includes 'POI Tools', 'Approval', and 'Fusion'.
- Current ROI:** Shows 'New ROI geometry' and 'CURRENT ROI'.
- Contouring:** Includes 'Brush', 'Smart contour', 'Spline', 'Polygon', and 'Freehand'.
- 3D Editing:** Includes 'Mode' (2D, 3D), 'Region growing', 'Deform', 'Translate', 'Rotate', 'Scale', 'Interpolate', 'Copy contour', 'Simpli', 'Paste contour', and 'Remo'.

The main display area shows three views of a patient's head and neck CT scan:

- 2D Axial View:** Shows a cross-section of the head and neck with various ROIs outlined in different colors (red, green, blue, yellow, magenta). Position: -8.27 -42.85 -0.68 cm. CT: -1000 HU.
- 2D Sagittal View:** Shows a side view of the head and neck with ROIs outlined. CT1 H&N 19OCT2015. Brilliance: 0.06 cm. Sagittal.
- 2D Coronal View:** Shows a front view of the head and neck with ROIs outlined. CT1 H&N 19OCT2015. Brilliance: -1.234 cm. Coronal.

The left sidebar lists various ROIs and materials:

- ROI:** External, CouchSurface, CouchInterior, CORD, BRSTEM, L COCHLEA, R COCHLEA, MANDIBLE, R PAROTID, L PAROTID, Post op bed, L neck, R neck, L neck PTV untrimmed, external - 0.3, R neck PTV untrimmed, L neck PTV trimmed, R neck PTV trimmed.

The bottom status bar shows the primary image set as 'CT1 H&N 19OCT2015' and the secondary image set as '-'. The system clock indicates 1:44 PM on 10/23/2015.

Patient Presentations

The treatment process – Patient A

- Develop a treatment plan (multimodality)
- Determine the appropriate RT modality
- Identify a target
- Identify surrounding normal tissue at risk
- Create a treatment plan (radiation)
- Deliver the treatment
- Follow the patient
- Returns to radiation oncology

Patient A

- 55 yo F with new lump in her left breast
- Suspicious abnormality on mammogram
- Biopsy consistent with infiltrating ductal carcinoma
- No family history of breast cancer

Treatment Plan

Develop a treatment plan

- Treatment options
 - Mastectomy
 - Breast Conserving Therapy (lumpectomy + RT)

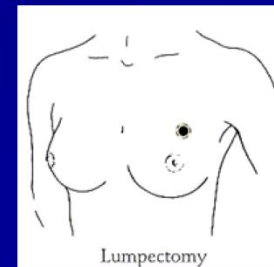
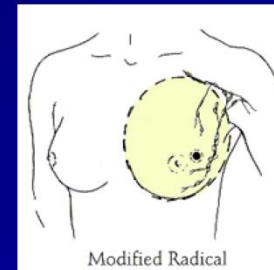
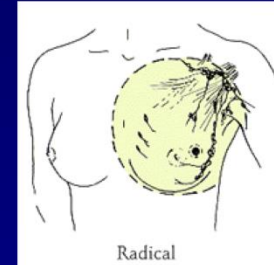

Patient A

- Selects breast conservation
- Lumpectomy and sentinel lymph node biopsy
- Pathology reveals a 3 cm tumor and 4 axillary lymph nodes
- The patient receives chemotherapy

Determine the RT Modality

Determine the RT modality

- External beam radiation
 - Protons
 - Photons
 - Electrons
- Brachytherapy
 - Sealed sources
 - Unsealed sources

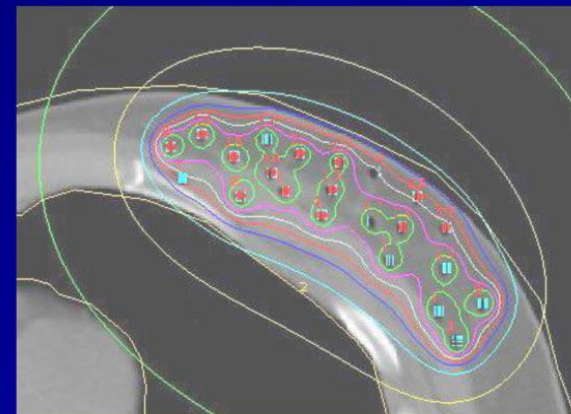
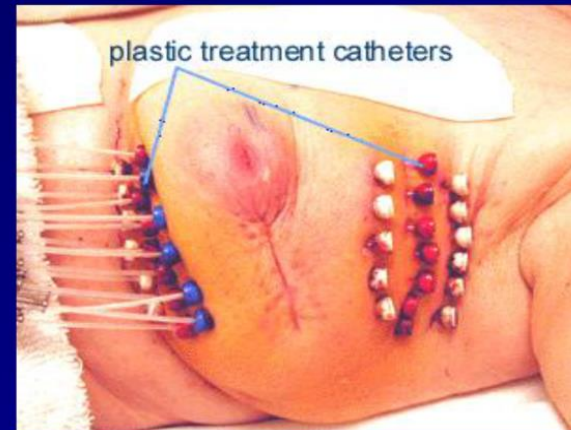

Identify the target and normal tissue - Simulation

Identify the target and normal tissue - Simulation

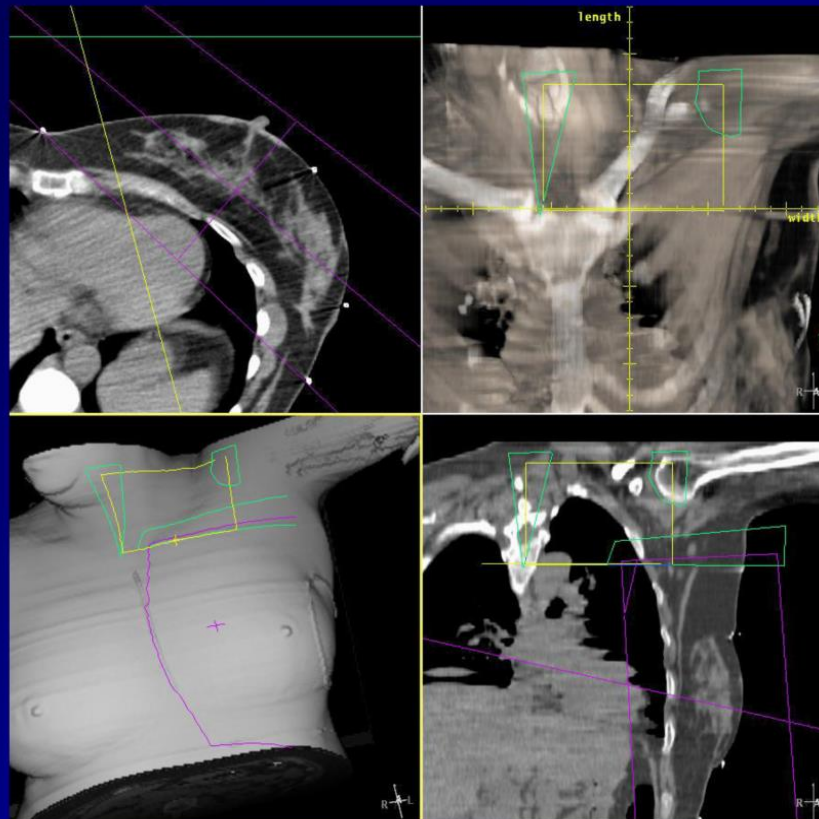

Create A Plan

Create a plan

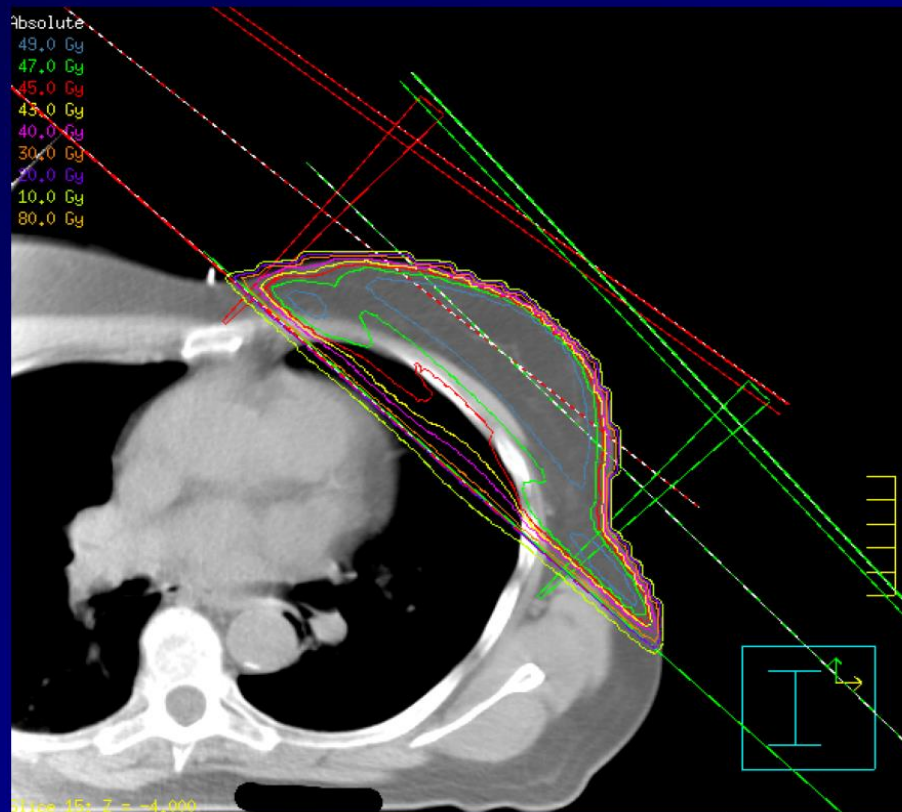

Deliver The Treatment

Deliver the treatment

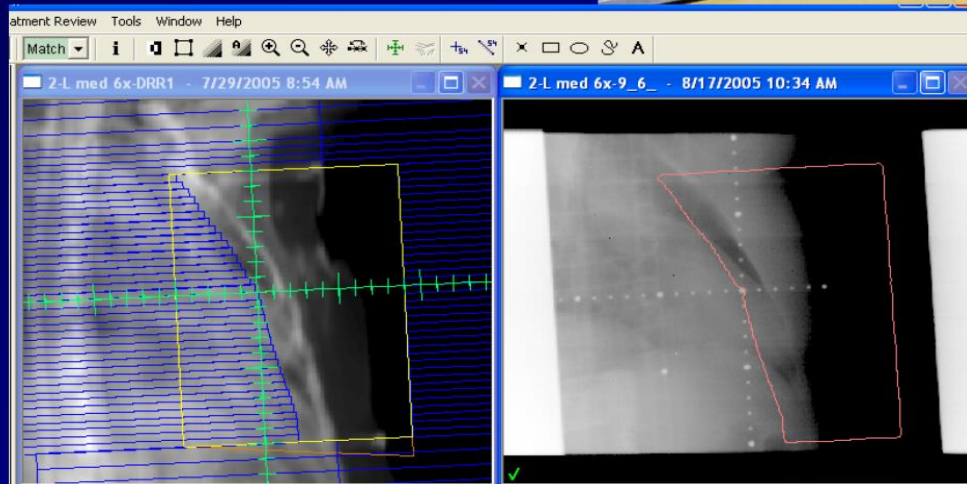

Patient B

- Patient B
 - 54 yo M with an elevated PSA on routine exam
 - No prior medical problems
 - Biopsy consistent with adenocarcinoma of the prostate, Gleason score of 6

Develop a treatment plan

- Surgery
- Surgery and radiation (based on surgical findings)
- Radiation
 - Brachytherapy
 - External beam RT
 - Combination
- Radiation and hormonal therapy

Create A Plan

Create a plan

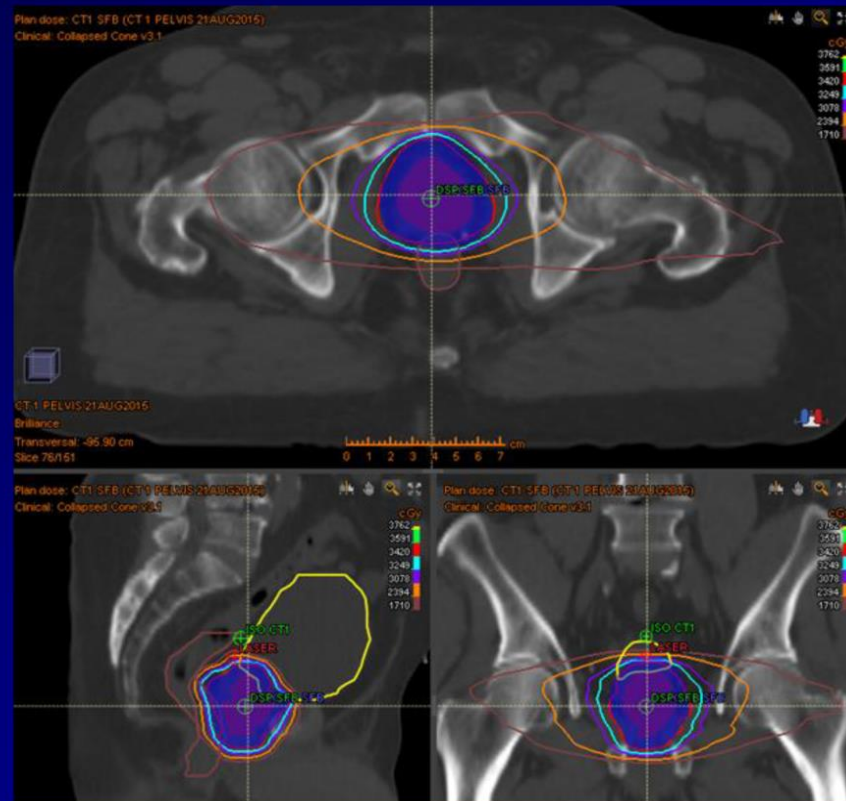
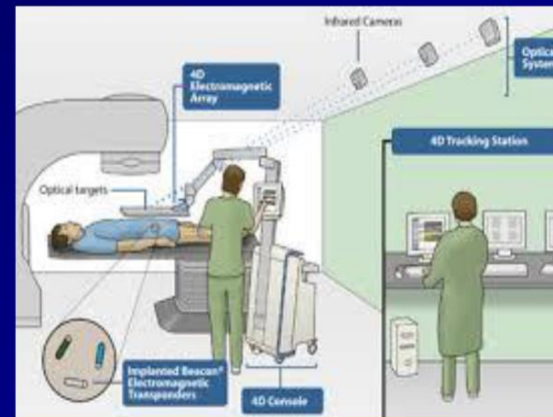

Image Guided Radiation Therapy

Image guided radiation therapy

- Calypso
- Gold fiducial markers



Image

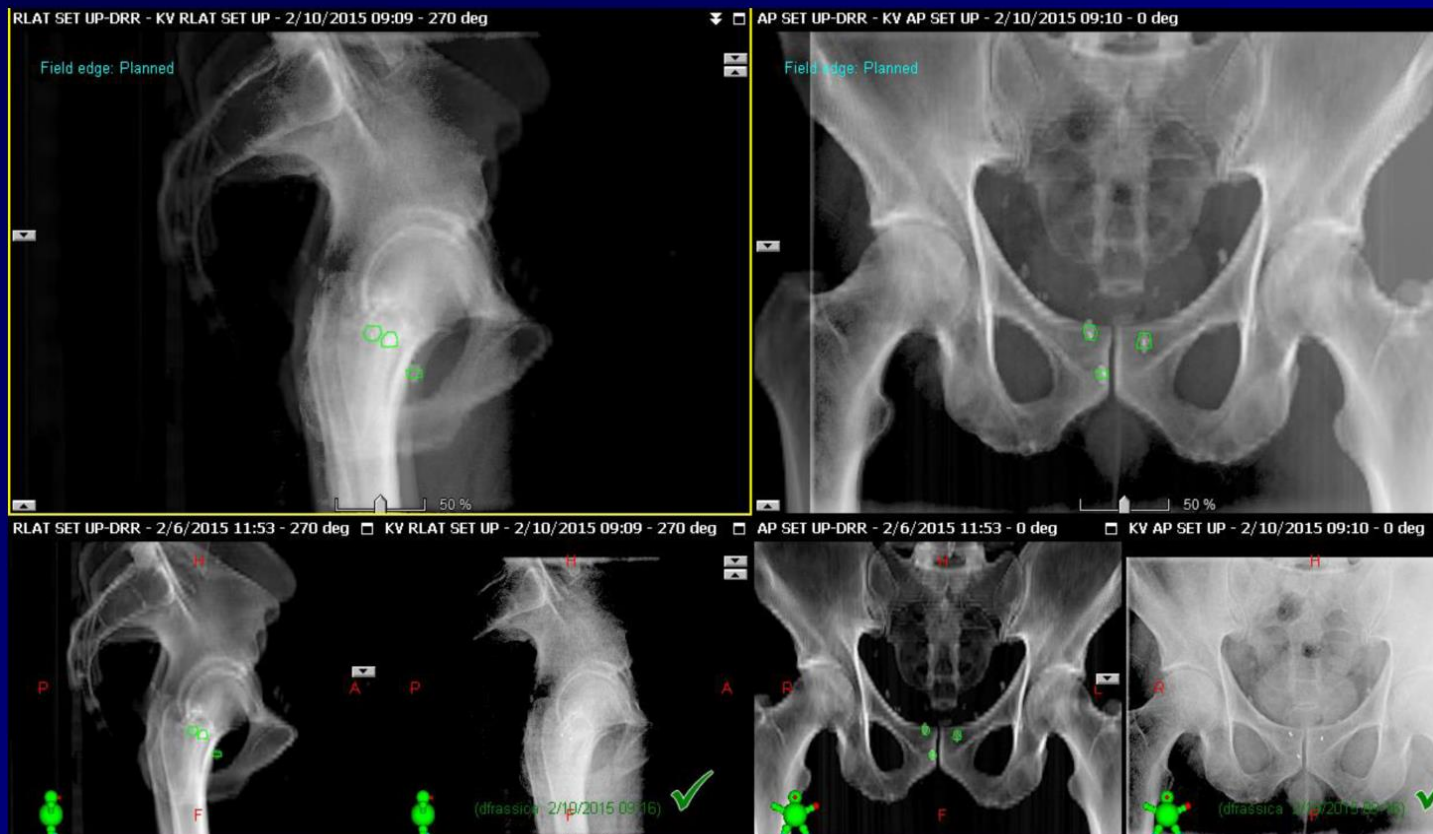

Image

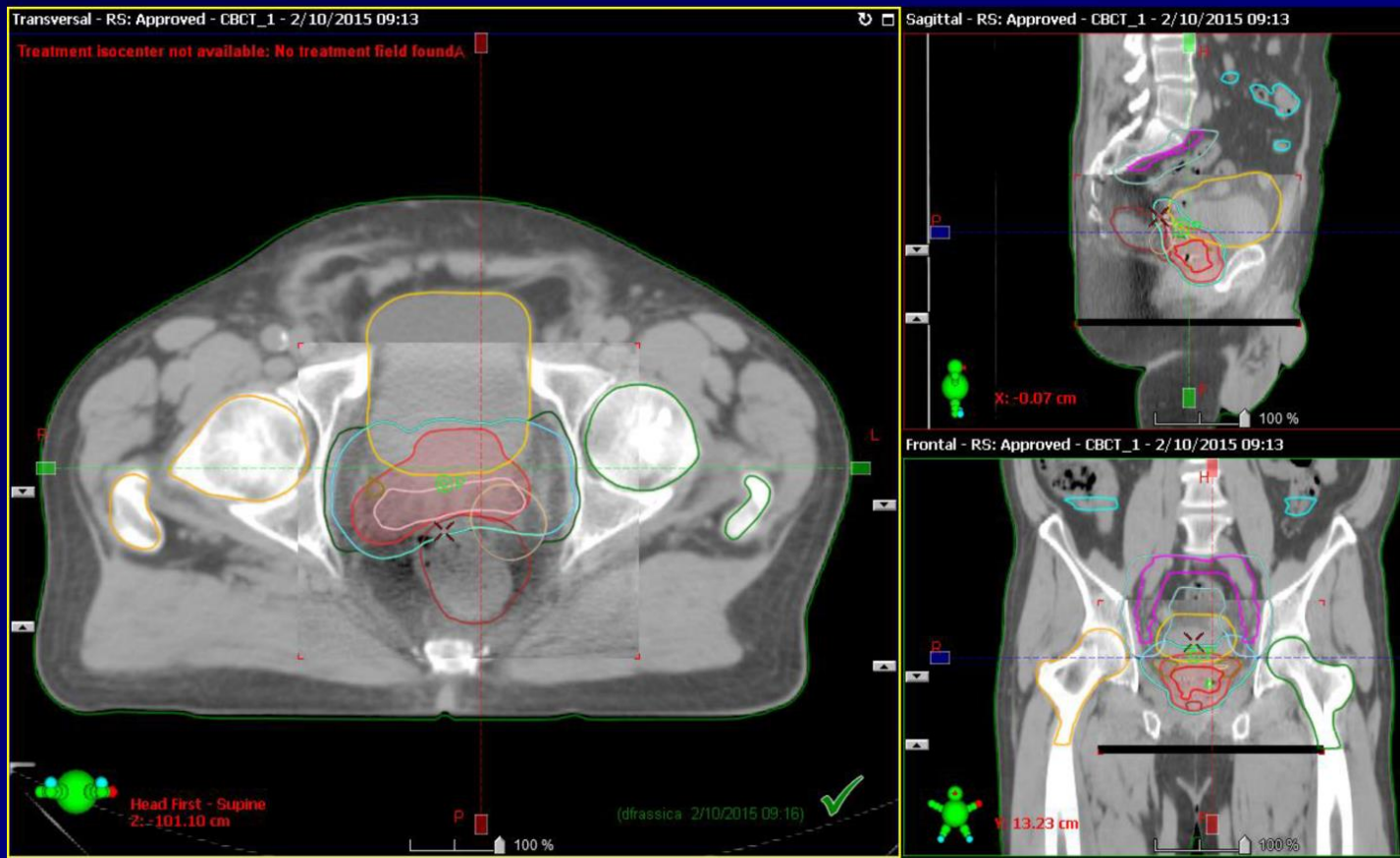

Deliver the Treatment

Deliver the treatment



Is it all just that easy?

- Normal tissue toxicity
 - Acute effects
 - Late effects
- Stem cell depletion, chronic oxidative damage, vascular destruction, fibrosis, and more
- Radiation is dosed to normal tissue, NOT tumor!

Lung - Fibrosis

Lung - Fibrosis

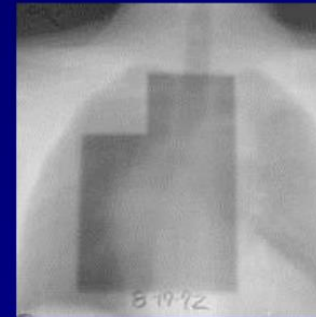
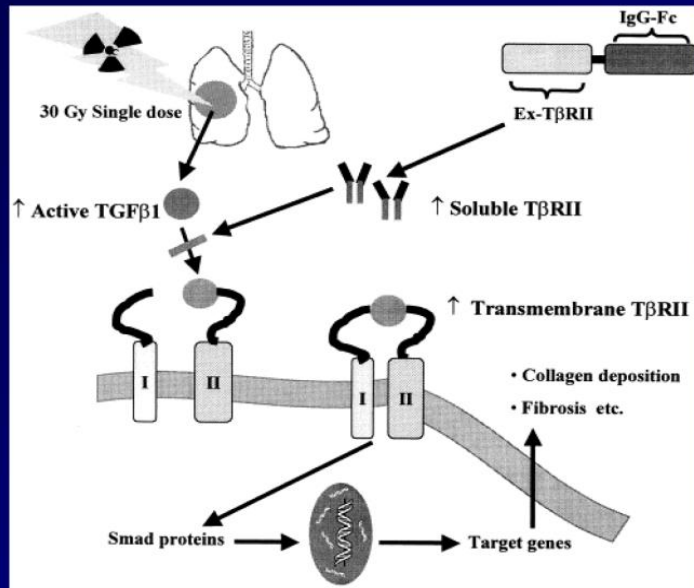

Lymphedema

Lymphedema – vessel damage

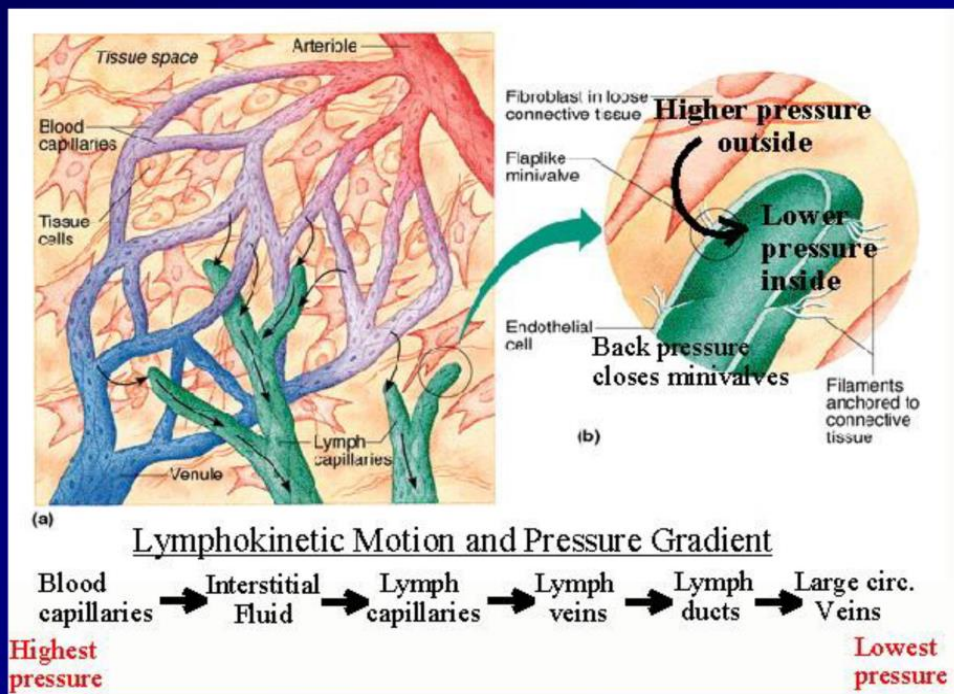

Mucositis

Mucositis – stem cell depletion



The future

- Where do we go from here?

The future of radiation

- **Biology**
 - Use radiation to induce targets for other agents
 - Better radiation sensitizers and protectors
 - Combining radiation and targeted drugs
- **Physics**
 - Improved targeting (imaging)
 - Improved delivery methods (equipment)
- **Clinical**
 - Translate exciting laboratory findings into the clinic
 - Continue to develop clinician-scientists

Why Protons Can be Superior to Photons

Why Protons Can be Superior to Photons

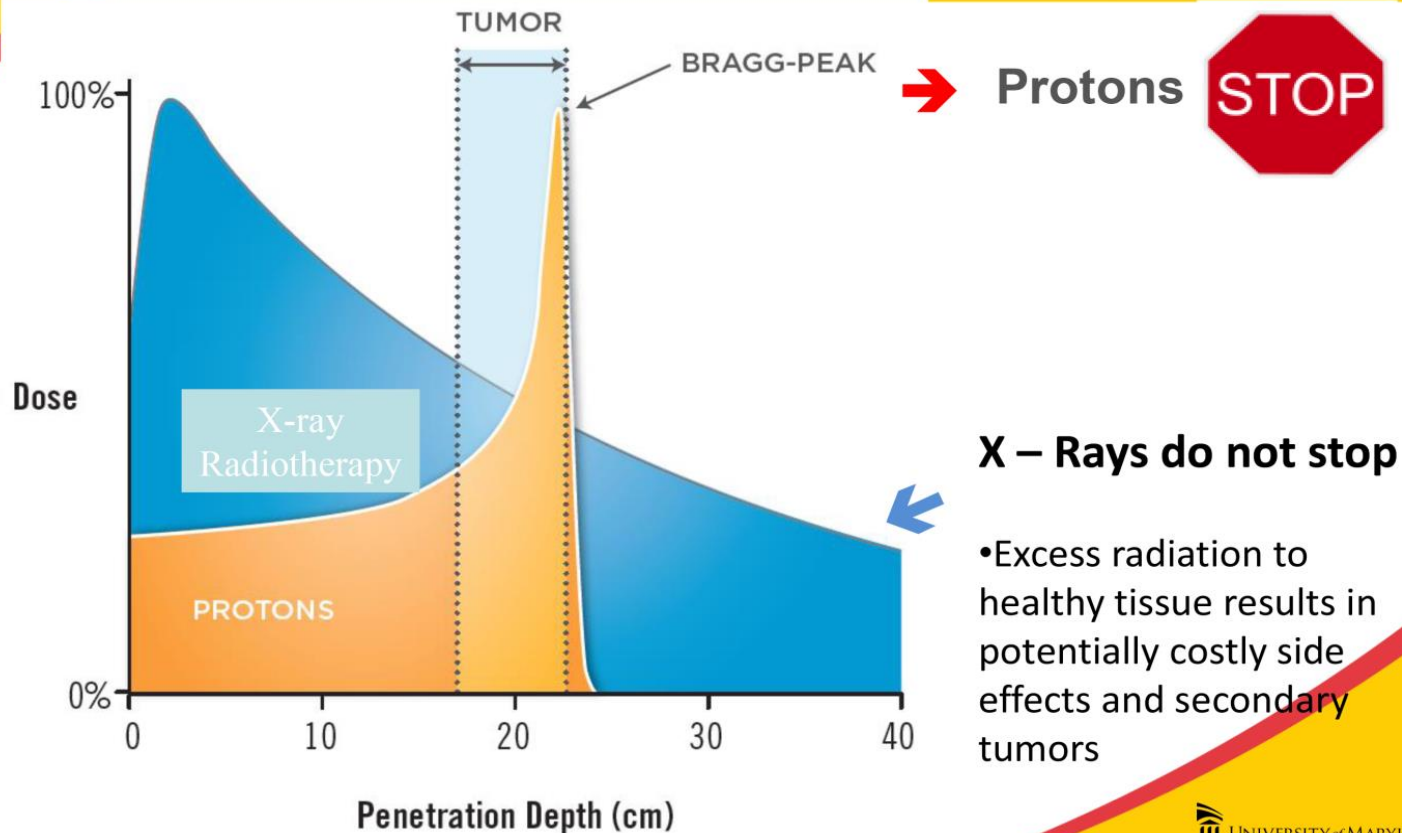

Proton Therapy

Proton Therapy Delivers Less Heart & Lung Dose

Protons

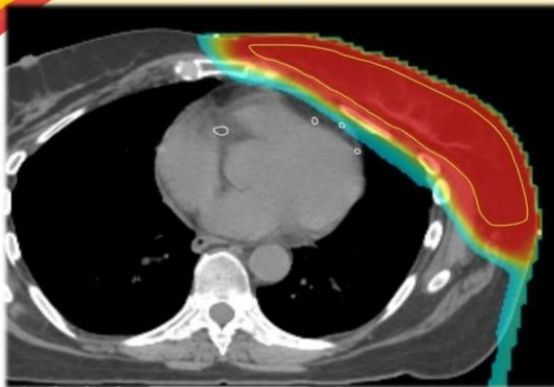

X-Rays (Current Radiation Treatment)

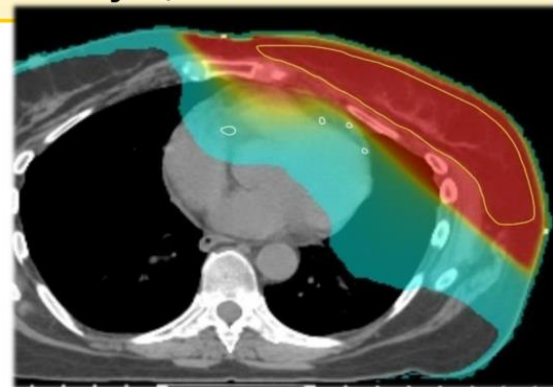

X-Rays Minus Protons

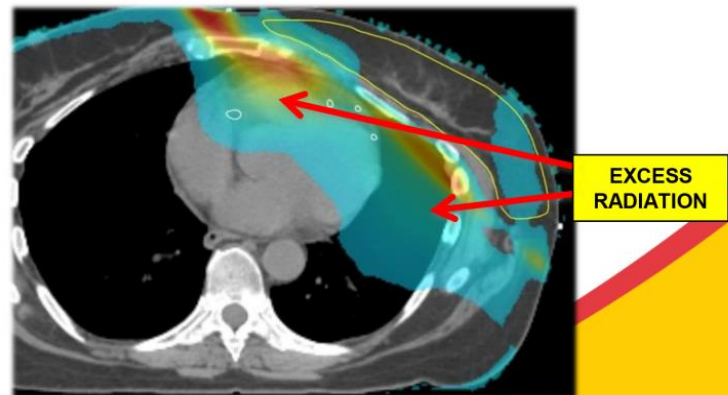

- **X-Rays Deliver Excess Radiation**
- **Resulting in**
 - **Coronary Artery Stenosis**
 - **Secondary Cancer**
 - **Lung Fibrosis**

Maryland Proton Treatment Center

***Maryland Proton Treatment Center (MPTC) –
A Regional Resource to Mid-Atlantic Healthcare Providers***



- \$200 million, 110,000 square feet, 5 treatment rooms, with unique patient thrupt process enhancing patient volume capacity allowing treatment of up to ~1900 patients/year (150-190 patients/day)

VISION

To become a Proton Center of Excellence across all academic missions,
accessible to and in PARTNERSHIP with major regional Health system/Oncology providers

Disease survival

Oligometastatic Disease

- Stereotactic body radiation therapy delivered to oligometastatic disease improves overall survival!

Results: Overall Survival

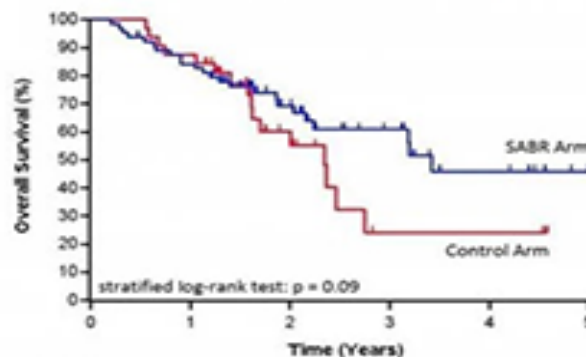

Median Overall Survival

Control Arm: 28 months
(95% CI: 19-33 months)

SABR Arm: 41 months
(95% CI: 26 months to 'not reached')

Number at risk:

Control	33	28	12	2	2	
SABR	66	53	29	15	7	1

Future directions

Future Directions in Radiation Therapy

- **Artificial Intelligence**
 - Automation of contouring and planning processes being evaluated
- **Continued development of combined therapies with radiation**
 - Chemotherapy/Systemic therapies
 - Other ablative therapies
 - Hyperthermia

Message

Take home messages

- Radiation is a tool used in cancer therapy
- Radiation causes DNA damage, which can lead to cell death
- The effects of radiation can be altered by modifying physical factors, physiologic factors, fractionation, drugs, and other variables
- Radiation can cause complications
- Radiation is INTERESTING!